

Play One

Small Tiles More Design

PLAYONE:
THE SMALL SIZES
AT GIGACER
PLAYONE: I PICCOLI
DI GIGACER

PlayOne is an articulated system of small sizes available in the **Gigacer** chromatic range, typically declined in big surfaces.

It is the game of combinations of shapes and colours.

The thin thickness always allows the combination with the big slabs, creating a combination within the big and the small with the continuous surface of the decorative pattern.

The low thickness of **Gigacer** is suitable both for floors and coverings, including on the inside all the horizontal and vertical surfaces.

PlayOne is an invite to customize the spaces, in order to transform a living space in our space.

PlayOne è un articolato sistema di piccoli formati della gamma cromatica **Gigacer**, tipicamente declinata in grandi superfici. È il gioco degli abbinamenti tra forme e colori.

Lo spessore sottile permette sempre l'abbinamento con la grande lastra, invitando alla combinazione del grande con il piccolo, della superficie continua con il pattern decorativo.

Il basso spessore di **Gigacer** è ideale sia per i pavimenti che i rivestimenti, includendo al suo interno tutte le superfici orizzontali e verticali.

PlayOne è un invito alla personalizzazione degli ambienti, il modo per trasformare uno spazio abitativo nel nostro spazio.



INDEX INDICE

2	PLAYONE
4	SHAPES
5	SIZES AND THICKNESSES FORMATI E SPESSORI
6	COLOURS COLORI
7	PROJECTS PROGETTI
22	MOSAICS
23	SIZES AND THICKNESSES FORMATI E SPESSORI
24	COLOURS COLORI
26	PROJECTS PROGETTI
35	BRICK BAR
36	SIZES AND THICKNESSES FORMATI E SPESSORI
37	COLOURS COLORI
39	PROJECTS PROGETTI
42	LAYOUT SCHEMI DI POSA
45	PRODUCT GUIDE GUIDA PRODOTTO

An interior is
the natural projection
of your soul.

SHAPES

The rich choice of small shapes offers a clear synthesis of tradition and contemporaneity. Inside, **Shapes** includes a variety of polygons such as rhombuses, hexagons, pentagons, all modular between them.

The different compositions are a perfect combination between the research of the decoration and a minimalist style with a material aspect.

La ricca scelta di piccole forme offre una chiara sintesi di tradizione e contemporaneità.

Shapes al suo interno include vari poligoni come rombi, esagoni, pentagoni tutti modulari tra di loro.

Le diverse composizioni sono un perfetto connubio tra la ricerca della decorazione e uno stile minimalista dall'aspetto materico.

SIZES AND THICKNESSES FORMATI E SPESSORI

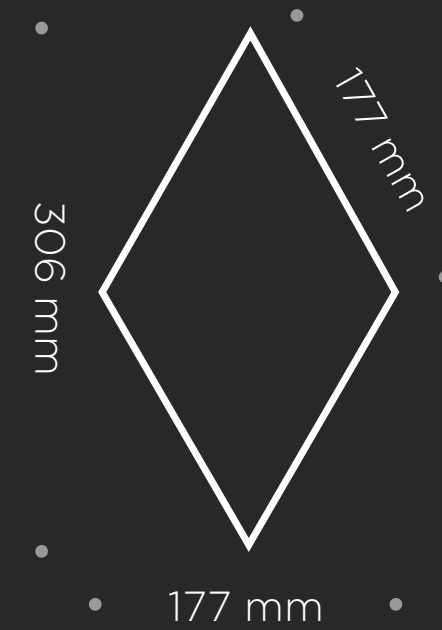

DIAMOND
18x31 cm 7"x12"

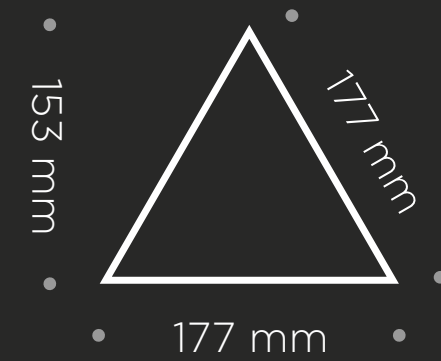

TRIANGLE
18x16 cm 7"x6"

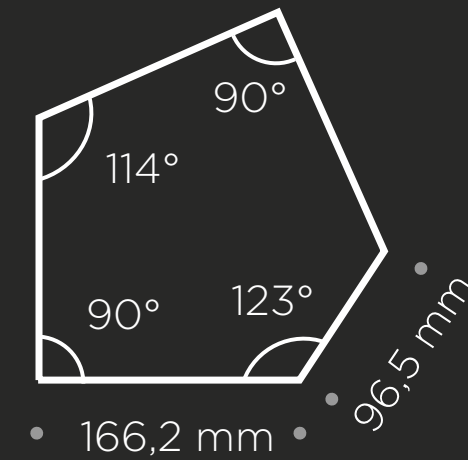

SMALL PENTAGON
17x10 cm 7"x4"

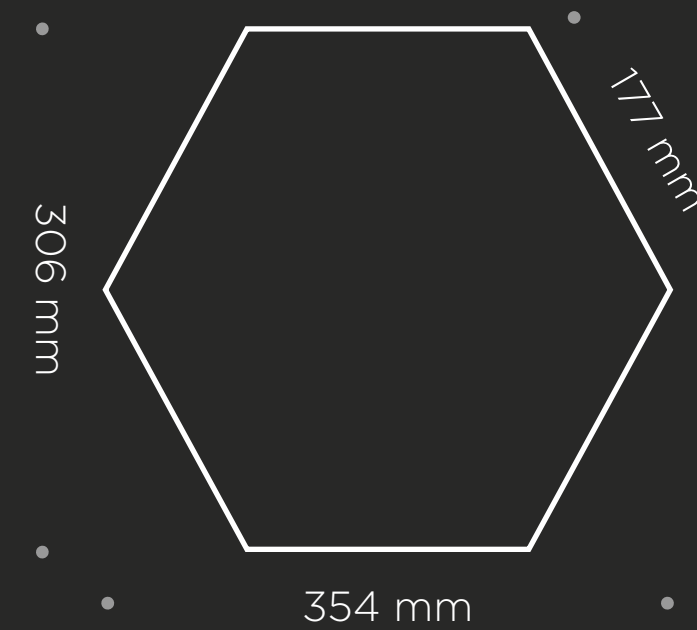

LARGE HEXAGON
36x31 cm 14"x12"

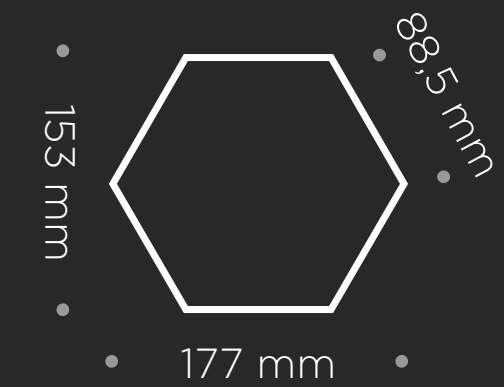

SMALL HEXAGON
18x16 cm 7"x6"

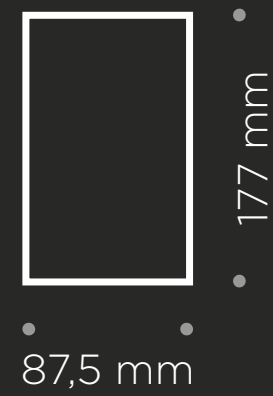

BRICK
9x18 cm 3 1/2"x7"

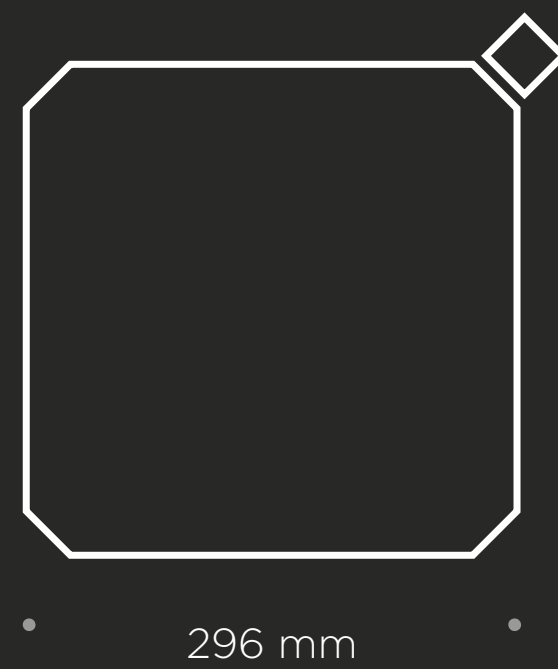

OCTAGON
30x30 cm 12"x12"

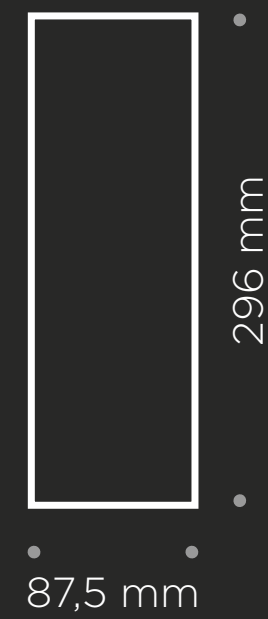
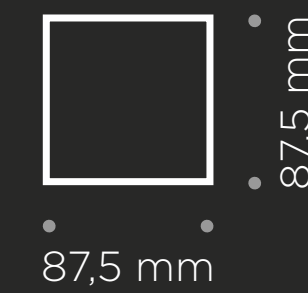
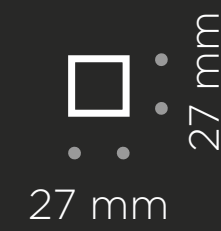

PLATE
9x30 cm 3 1/2"x12"



SMALL
9x9 cm 3 1/2"x3 1/2"



BUTTON
3x3 cm 1 1/4"x1 1/4"

≈4.8mm
CONCRETE / KREA

≈6mm
ARGILLA / CONCEPT 1 / CONCRETE PURE / CONCRETE BLACK / LIGHT

ARGILLA | ≈ 6 mm



CONCRETE | ≈ 4.8 mm

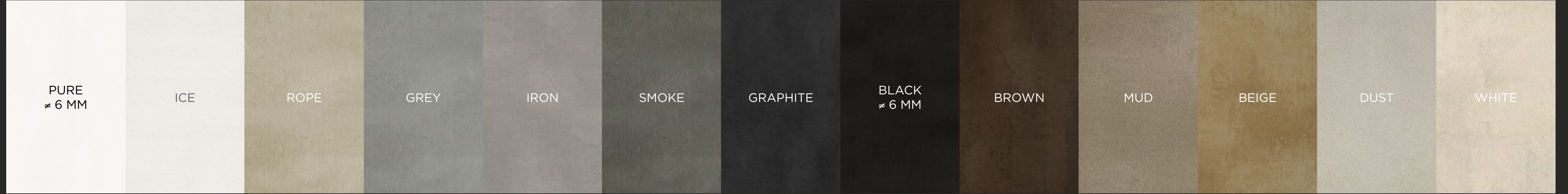

KREA | ≈ 4.8 mm



LIGHT | ≈ 6 mm

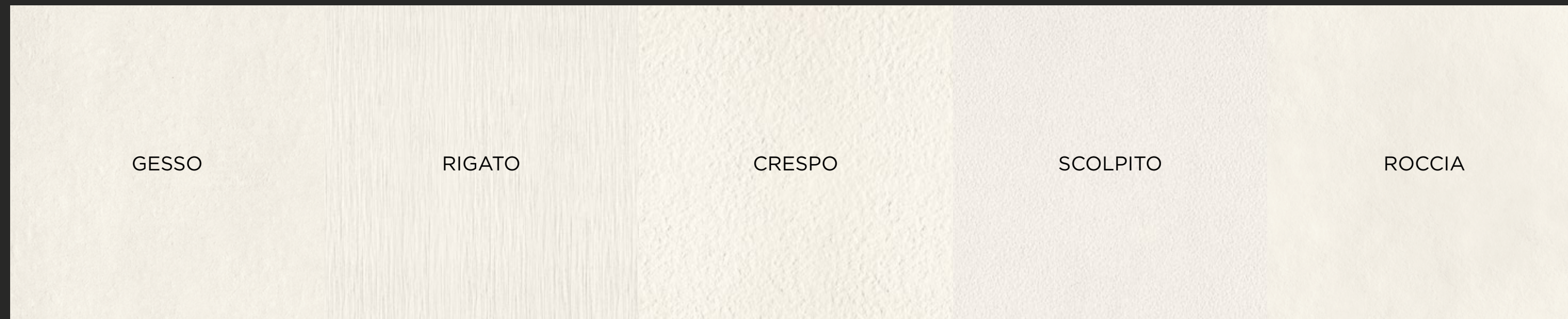

CONCEPT 1 | ≈ 6 mm
MAT | LEVIGATO
TEXTURE MAT | TEXTURE LEV





An innovative geometric shape dedicated to architecture.

- 1. / 2.
- WALL | PARETE
- Argilla Marine Material Small Pentagon 17x10 cm / 7"x4" / #6 mm
- Argilla Biacca Material Small Pentagon 17x10 cm / 7"x4" / #6 mm
- TOP | PIANO
- Concrete White / #12 mm Gigacer Service
- FLOOR | PAVIMENTO
- Argilla Marine Quartz 60x60 cm / 24"x24" / #12 mm



3.

WALL | PARETE

Concrete Ice, Concrete Graphite Diamond

18x31 cm / 7"x12" ±4.8 mm

Concrete Ice

10x60 cm / 4"x24" / ±4.8 mm **Gigacer Service**

FLOOR | PAVIMENTO

Concrete Beige 120x120 cm / 48"x48" ±12 mm



4.

FLOOR | PAVIMENTO

Krea Snow, Krea Green 30x30 cm / 12"x12" / ±4.8 mm **Gigacer Service**

Krea Red Diamond 18x31 cm / 7"x12" / ±4.8 mm

Krea Silver Plate 9x30 cm / 3 1/2"x12" / ±4.8 mm

Krea Silver Brick 9x18 cm / 3 1/2"x7" / ±4.8 mm

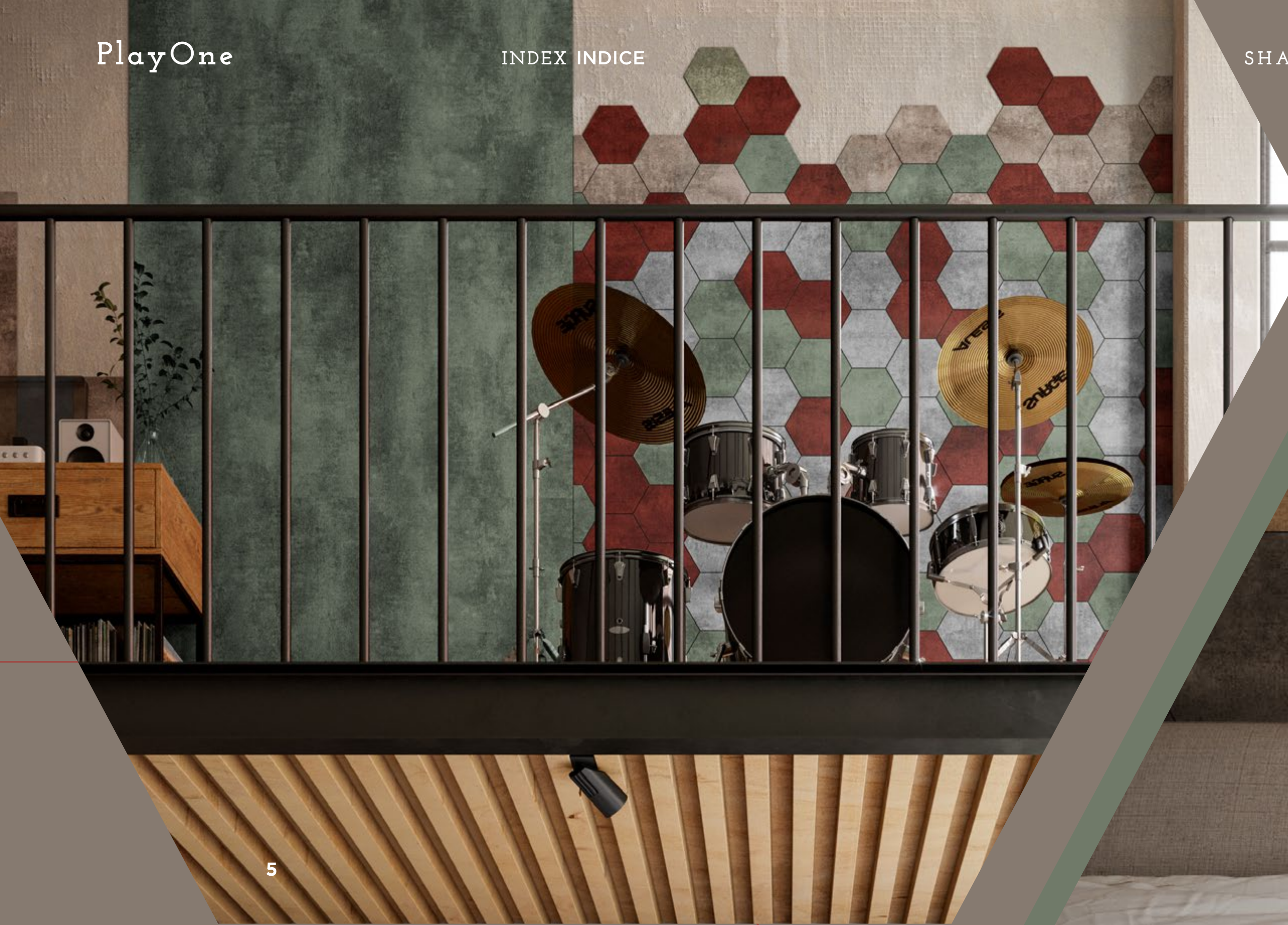

5.
WALL | PARETE
Krea Green, Krea Red, Krea Snow Small Hexagon 18x16 cm / 7"x6" / ≠4.8 mm

6.
FLOOR | PAVIMENTO
Krea Ground 120x120 cm / 48"x48" / ≠12 mm
WALL | PARETE
Krea Ground, Krea Orange Large Hexagon 36x31 cm / 14"x12" / ≠4.8 mm



**7.**

WALL | PARETE

Concrete Ice, Concrete White, Concrete Rope Diamond

18x31 cm / 7"x12" / ≠4.8 mm

Concrete Ice 15x60 cm / 6"x24" / 10x60 cm / 4"x24" / ≠4.8 mm **Gigacer Service**

FLOOR | PAVIMENTO

Concrete Rope 60x120 cm / 24"x48" ≠4.8 mm**Concrete White Stripe Mosaic** 15x120 cm / 6"x48" / ≠4.8 mm

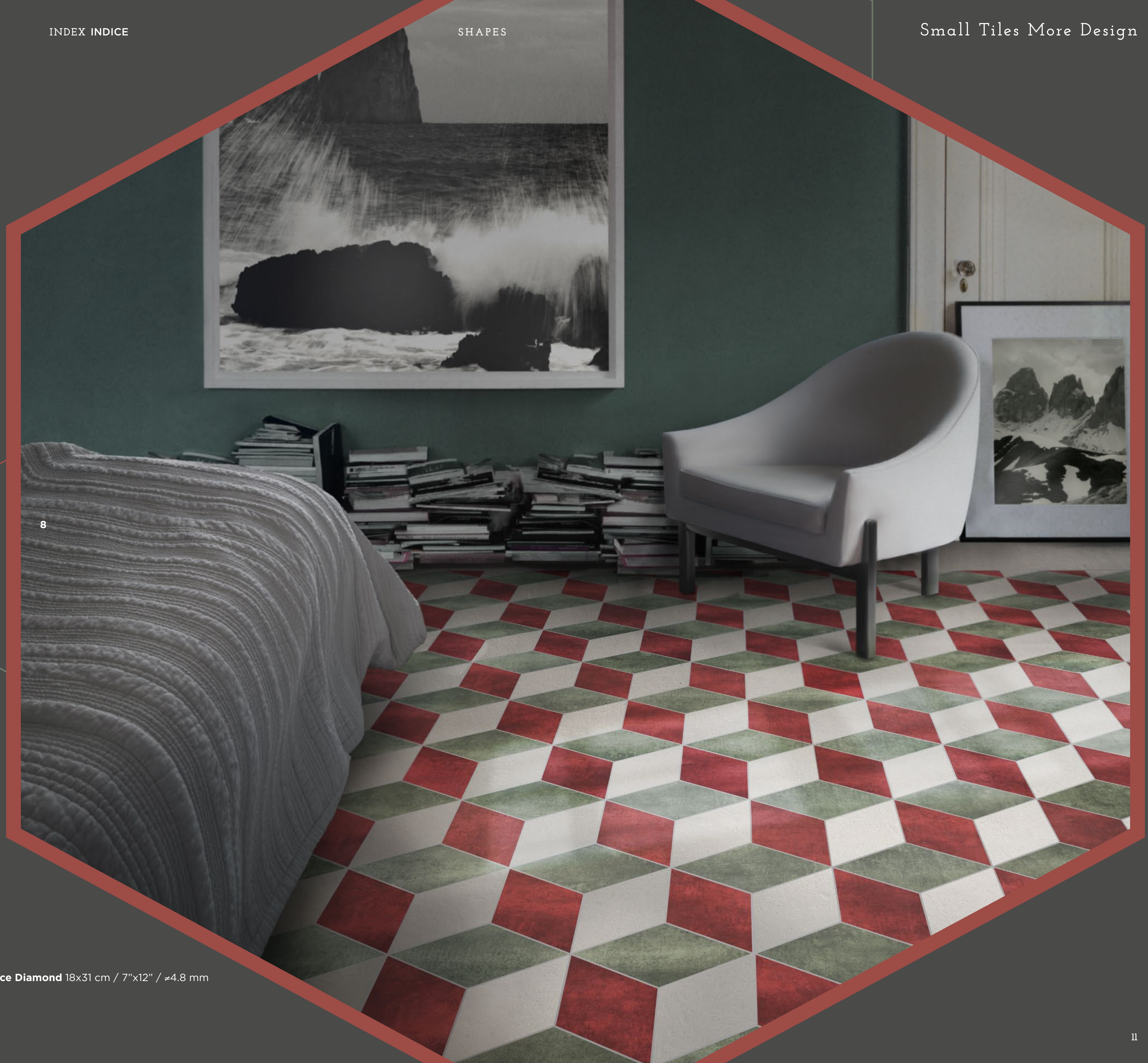

8

8.
FLOOR | PAVIMENTO
Krea Red, Krea Green, Concrete Ice Diamond 18x31 cm / 7"x12" / \approx 4.8 mm



9.

WALL | PARETE

Concrete White 120x120 cm / 48"x48" / ≠4.8 mm

FLOOR | PAVIMENTO

Concrete White, Krea Blue Diamond 18x31 cm / 7"x12" / ≠4.8 mm**Concrete White** 10x60 cm / 4"x24" / 20x120 cm / 8"x48" **Gigacer Service**



10

10.

WALL | PARETE

Krea Orange

120x120 cm / 48"x48" / ≠4.8 mm

Krea Orange Stripes Mosaic

15x120 cm / 6"x48" / ≠4.8 mm

FLOOR | PAVIMENTO

Krea Orange, Concrete Beige, Concrete White Diamond

18x31 cm / 7"x12" / ≠4.8 mm

11.

FLOOR | PAVIMENTO

Concrete Graphite, Concrete Beige Plate 9x30 cm / 3 1/2"x12" / ≠4.8 mm

Concrete Beige, Concrete Grey, Krea Nut Diamond 18x31 cm / 7"x12" / ≠4.8 mm



12

12.

FLOOR | PAVIMENTO

Concrete Ice Octagon 30x30 cm / 12"x12" / \approx 4.8 mm
Concrete Graphite, Concrete Ice 30x30 cm / 12"x12" / \approx 4.8 mm
Concrete Graphite Button 3x3 cm / 1 1/4"x1 1/4" / \approx 4.8 mm

13

13.

FLOOR | PAVIMENTO

Concrete Ice, Concrete Graphite, Krea Snow Diamond18x31 cm / 7"x12" / \approx 4.8 mm**Concrete Ice, Krea Snow Plate** 9x30 cm / 3 1/2"x12" / \approx 4.8 mm**Concrete Graphite** 30x60 cm / 12"x24" / \approx 4.8 mm

14

14.
FLOOR | PAVIMENTO
Concrete Brown Octagon 30x30 cm
12"x12" / #4.8 mm
Concrete White Button 3x3 cm
1 1/4"x1 1/4" / #4.8 mm



15

15.

WALL | PARETE

Krea Snow 120x120 cm / 48"x48" / ≠4.8 mm

FLOOR | PAVIMENTO

Concrete Ice, Krea Blue, Krea Red Diamond
18x31 cm / 7"x12" / ≠4.8 mm



16

16.

WALL | PARETE

Krea Orange, Krea Ground Small Hexagon 18x16 cm / 7"x6" / ≠4.8 mm

DOUBLE WASHBASIN | LAVABO DOPPIO

Concrete Graphite 180x50 / 71"x19 1/2" ≠6 mm

17.

WALL | PARETE

Concrete Graphite, Krea Green, Krea Snow Diamond 18x31 cm / 7"x12" / ≠4.8 mm**Concrete Graphite** 120x250 cm / 48"x100" / ≠6 mm

17





- 18.**
 FLOOR | PAVIMENTO
Concrete Beige, Concrete White 30x30 cm / 12"x12" / ≠4.8 mm
Krea Nut Plate 9x30 cm / 3 1/2"x12" / **Small** 9x9 cm / 3 1/2"x3 1/2" / ≠4.8 mm
- 19.**
 FLOOR | PAVIMENTO
Krea Orange, Concrete Beige, Concrete White Diamond
 18x31 cm / 7"x12" / ≠4.8 mm

**20.**

FLOOR | PAVIMENTO

Concrete Graphite, Concrete Ice

Small 9x9 cm / 3 1/2"x3 1/2" / #4.8 mm

Brick 9x18 cm / 3 1/2"x7" / #4.8 mm

Plate 9x30 cm / 3 1/2"x12" / #4.8 mm

Diamond 18x31 cm / 7"x12" / #4.8 mm



20



21

20.

BAR COUNTER | BANCONE BAR

Concept 1 Ink Flame Texture Mat, Ink Red Texture Mat Small

9x9 cm / 3 1/2"x3 1/2" / ≠6 mm

BAR COUNTER TOP | BANCONE BAR

Concept 1 Ink Levigato ≠12 mm / Gigacer Service

WALL | PARETE

Concept 1 Ink Texture Levigato 120x250 cm / 48"x100" / ≠6 mm**21.**

FLOOR | PAVIMENTO

Concrete Rope 30x30 cm / 12"x12" / ≠4.8 mm**Concrete White Plate** 9x30 cm / 3 1/2"x12" / ≠4.8 mm**Concrete Rope Small** 9x9 cm / 3 1/2"x3 1/2" / ≠4.8 mm



MOSAICS

The mosaic size of **Gigacer** resumes the strong passion of the company for the detail. Every **Gigacer's** colour range has its mosaic sizes which allows to complete and enrich spaces with precious finishes, offering solutions for curved surfaces or emphasize certain projects.

The textures of the mosaic in all the shades are the accent to the classic minimalism of the **Gigacer** collections and allow You to offer a unique chromatic palette in porcelain stoneware.

Il formato mosaico di **Gigacer** riassume la forte passione dell'azienda per il dettaglio. Ogni colore della gamma **Gigacer** ha al suo interno il formato mosaico che permette di completare e arricchire di pregiate finiture gli ambienti, offrire soluzioni per superfici curve o sottolineare determinati particolari di progetto.

Le trame del mosaico in tutte le tonalità sono l'accento al minimalismo classico delle collezioni **Gigacer** e permettono di offrire una palette cromatica unica nel gres porcellanato.

FORMATI E SPESSORI SIZES AND THICKNESSES

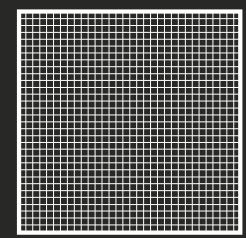

MOSAIC 0.7x0.7
30x30 cm 12"x12"



≠4.8 mm
CONCRETE
≠6 mm
CONCRETE Black e Pure

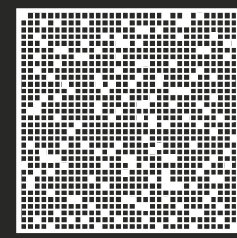

MIX MOSAIC 0.7x0.7
30x30 cm 12"x12"



≠6 mm
mix mat/levigato
CONCEPT 1

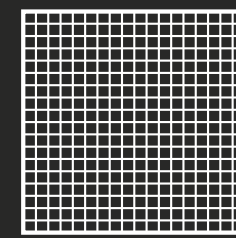

MOSAIC 1.5x1.5
30x30 cm 12"x12"



≠4.8 mm
CONCRETE / KREA
≠6 mm
ARGILLA / CONCRETE Black e Pure

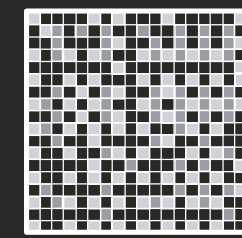

MIX MOSAIC 1.5x1.5
30x30 cm 12"x12"



≠4.8 mm
mix of all colours
KREA
≠6 mm
mix of all surfaces
LIGHT

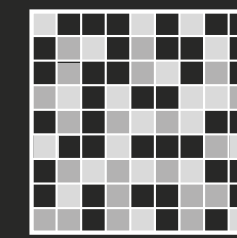

MIX MOSAIC 3x3
30x30 cm 12"x12"



≠12 mm
mix mat/boc
QUARRY
≠6 mm
mix of all surfaces
LIGHT

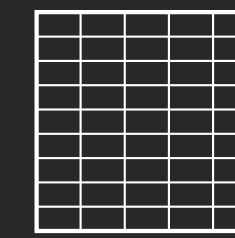

MOSAIC 3x6
30x30 cm 12"x12"



≠6 mm
ARGILLA

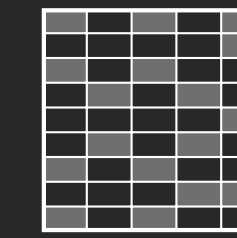

MIX MOSAIC 3x6
30x30 cm 12"x12"



≠6 mm
mix of all surfaces
LIGHT

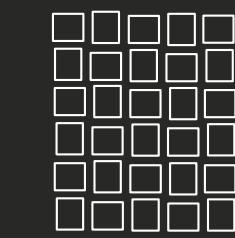

ACTION MOSAIC
30x30 cm 12"x12"



≠4.8 mm
CONCRETE
≠6 mm
CONCRETE Black e Pure

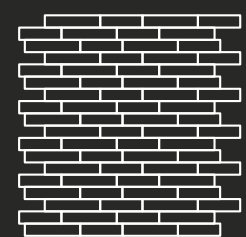

WALL MOSAIC
30x30 cm 12"x12"



≠4.8 mm
CONCRETE
≠6 mm
CONCRETE Black e Pure

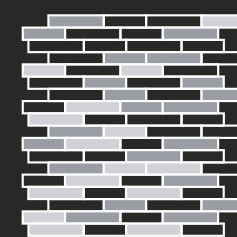

WALL MOSAIC MIX
30x30 cm 12"x12"



≠4.8 mm
CONCRETE
MIX A
White, Beige, Brown
MIX B
Grey, Smoke, Graphite, White

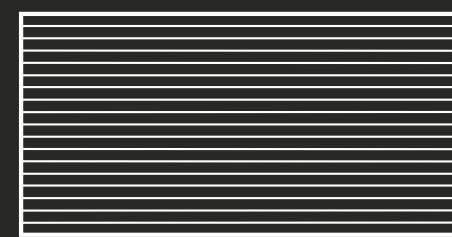

STRIPES MOSAIC
30x60 cm 12"x24"



≠4.8 mm
CONCRETE / KREA
≠6 mm
CONCRETE Black e Pure



STRIPES MOSAIC 1.5x120
15x120 cm 6"x48"



≠4.8 mm
CONCRETE / KREA
≠6 mm
ARGILLA / CONCRETE Black e Pure



MIX STRIPES MOSAIC 1.5x120
15x120 cm 6"x48"



≠4.8 mm
mix of all colours
KREA
≠6 mm
mix of all surfaces
LIGHT

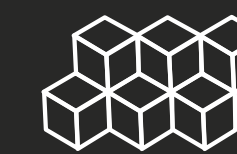

MIX 3D MOSAIC
30x17 cm 12"x6 1/2"



≠6 mm
mix of all surfaces
LIGHT

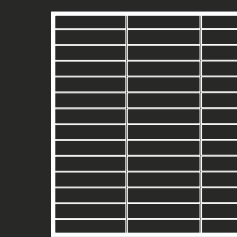

MOSAIC TRAIL
30x30 cm 12"x12"



≠12 mm
QUARRY

ARGILLA | ≈ 6 mm



CONCRETE | ≈ 4.8 mm



CONCRETE | ≈ 6 mm

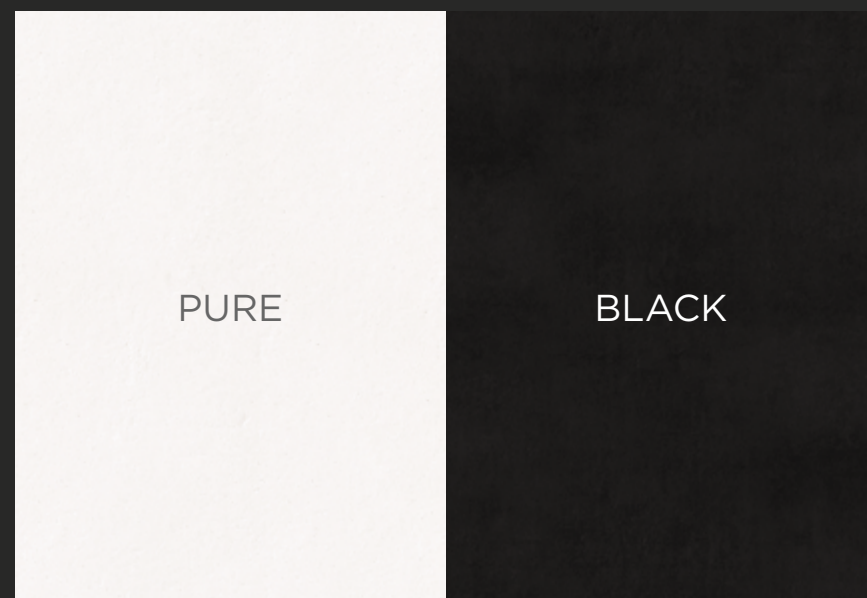

LIGHT | ≈ 6 mm



CONCEPT 1 | ≈ 6 mm



KREA | ≈ 4,8 mm

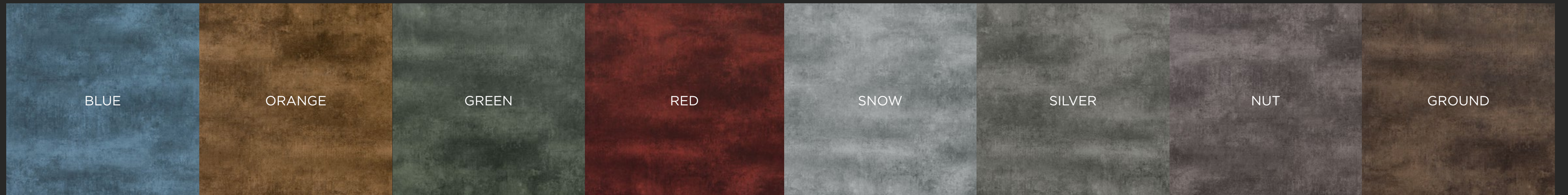

QUARRY | ≈ 12 mm

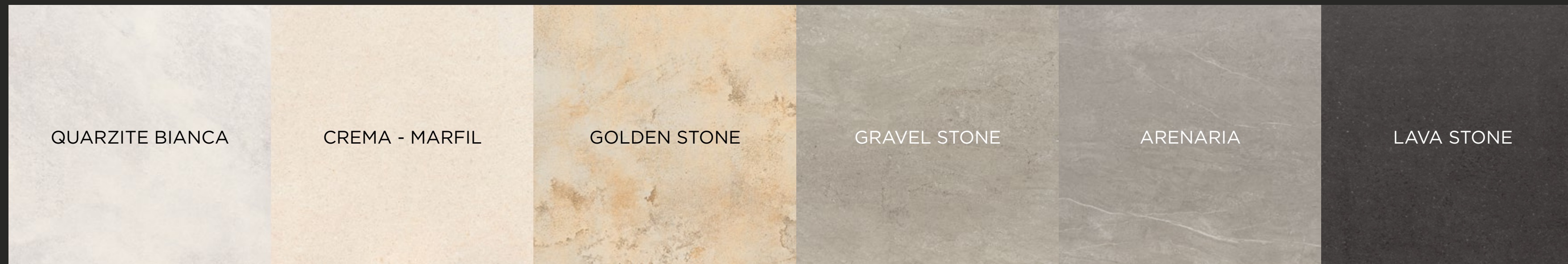



1.

FLOOR | PAVIMENTO

Stone Mat / Levigato Mosaic 0.7x0.7 30x30 cm / 12"x12" / ≠6 mm

WALL | PARETE

Stone Mat / Levigato Mosaic 0.7x0.7 30x30 cm . 12"x12" ≠6 mm

2.

FLOOR | PAVIMENTO

Stone Mat / Levigato Mosaic 0.7x0.7 30x30 cm / 12"x12" / ≠6 mm**Stone Levigato** 60x120 cm / 24"x48" / ≠6 mm**Stone Mat** 120x120 cm / 48"x48" / ≠6 mm

WALL | PARETE

Stone Mat / Levigato Mosaic 0.7x0.7 30x30 cm / 12"x12" / ≠6 mm**Stone Mat** 60x250 cm / 24"x100" / ≠6 mm**Stone Levigato** 60x250 cm / 24"x100" / ≠6 mm**Stone Texture Levigato** 120x250 cm / 48"x100" / ≠6 mm

2



- 3.**
WALL | PARETE
Argilla Vetiver Material 60x120 cm / 24"x48" / ≠6 mm
Argilla Vetiver Material Stripes Mosaic 15x120 cm / 6"x48" / ≠6 mm
- 4.**
WALL | PARETE
Argilla Vetiver Material Mosaic 1.5x1.5 30x30 cm / 12"x12" / ≠6 mm
MIDDLE WASHBASIN | LAVABO MIDDLE
Argilla Vetiver Material 119x50 cm / 48"x19 1/2" / ≠6 mm



5.

WALL | PARETE

Krea Blue 120x120 cm / 48"x48" / ≠4.8 mm

FLOOR | PAVIMENTO

Krea Blue Mosaic 1.5x1.5 30x30 cm / 12"x12" / ≠4.8 mm

6.

FLOOR | PAVIMENTO

Krea Ground 120x120 cm / 48"x48" / ≠4.8 mm**Krea Orange Mosaic 1.5x1.5** 30x30 cm / 12"x12" / ≠4.8 mm

WALL | PARETE

Krea Orange Mosaic 1.5x1.5 30x30 cm / 12"x12" / ≠4.8 mm**Krea Orange** 120x250 cm / 48"x100" / ≠6 mm



7.
FLOOR | PAVIMENTO

Argilla Fog Material 120x120 cm / 48"x48" / ≠6 mm

WALL | PARETE

Argilla Dark Material Mosaic 6x3 30x30 cm / 12"x12" / ≠6 mm

COUNTER TOP COFFEE TABLE | PIANO DEI TAVOLINI

All Argilla Colours Material / ≠6 mm **Gigacer Service**

COUNTER | BANCONE

Concrete Pure / ≠6 mm **Gigacer Service**

8.
WALL | PARETE

Argilla Dark Material Mosaic 6x3 30x30 cm / 12"x12" / ≠6 mm

COUNTER | BANCONE

Concrete Black / ≠6 mm **Gigacer Service**



9.
WALL | PARETE
Concrete Rope
15x60 cm / 6"x12" / #4.8 mm
Action Mosaic
30x30 cm / 12"x12" / #4.8 mm

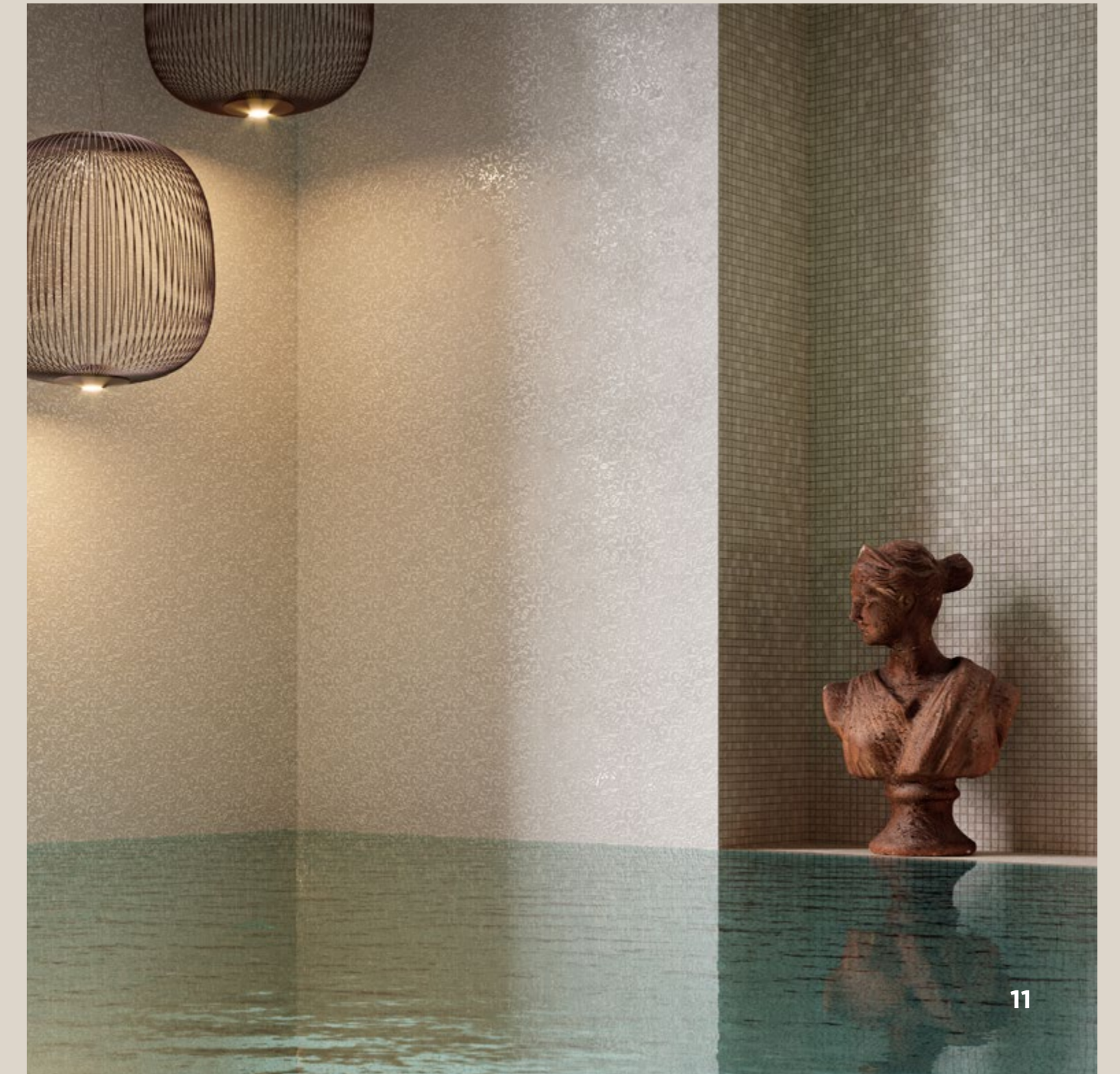

- 10.**
WALL | PARETE
Light Gesso 15x60 cm / 6"x24" / ≠6 mm
Light Mix Mosaic 3x6 30x30 cm / 12"x12" / ≠6 mm
- 11.**
WALL | PARETE
Light Mix Mosaic 1.5x1.5 30x30 cm / 12"x12" / ≠6 mm
Light 250 Curtain 120x250 cm / 48"x100" / ≠6 mm



12

12.

WALL | PARETE

Concept 1 Ink Mat 60x250 cm / 24"x100" / 6 mm**Concept 1 Ink Turquoise Texture Mat**

60x250 cm / 24"x100" / 6 mm

Concept 1 Ink Levigato 60x250 cm / 24"x100" / 6 mm**Concept 1 Ink Mosaic 0.7x0.7** 30x30 cm / 12"x12" / 6 mm

13.

WALL | PARETE

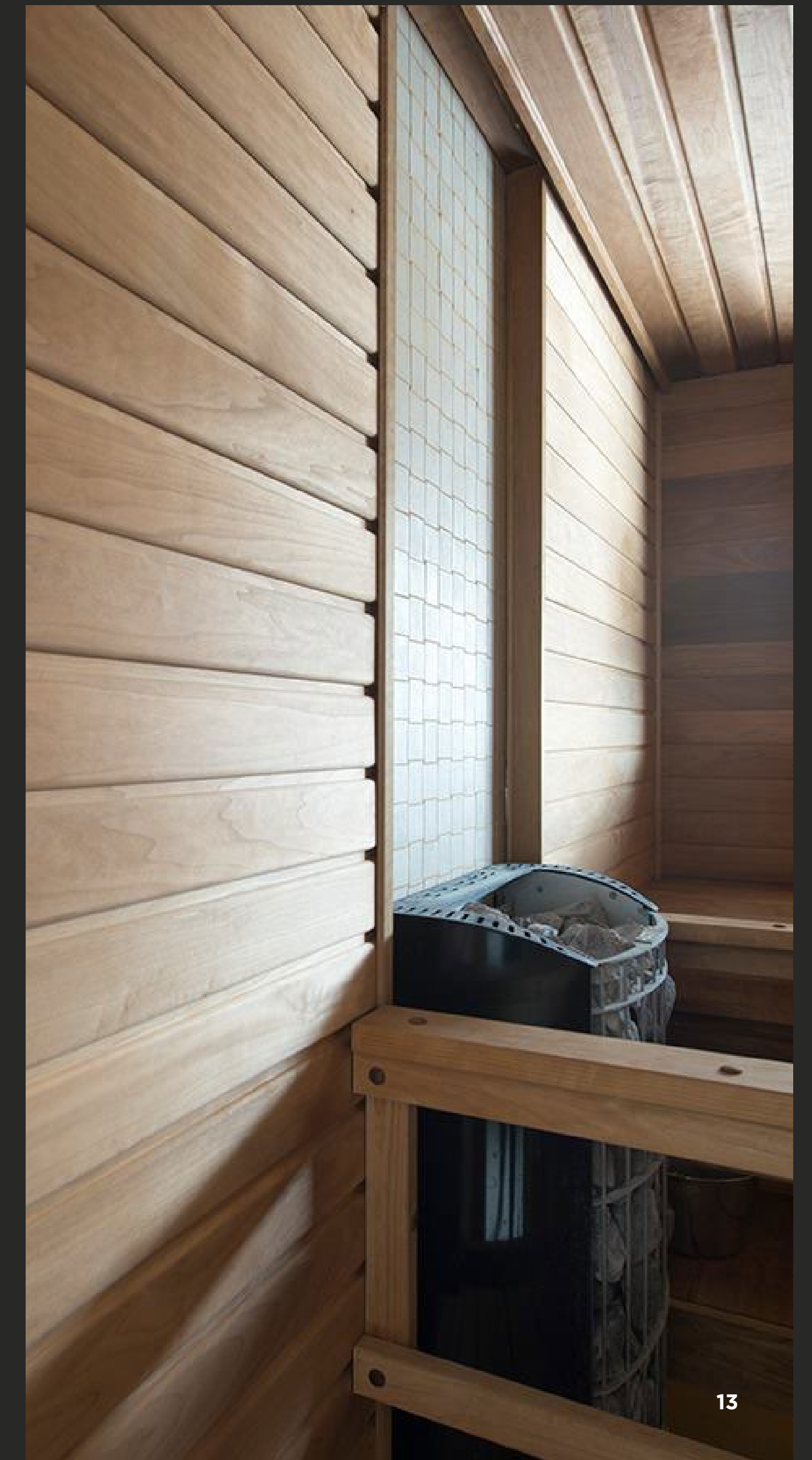
Concrete White Wall Mosaic 30x30 cm / 12"x12" / 4.8 mm

13



14

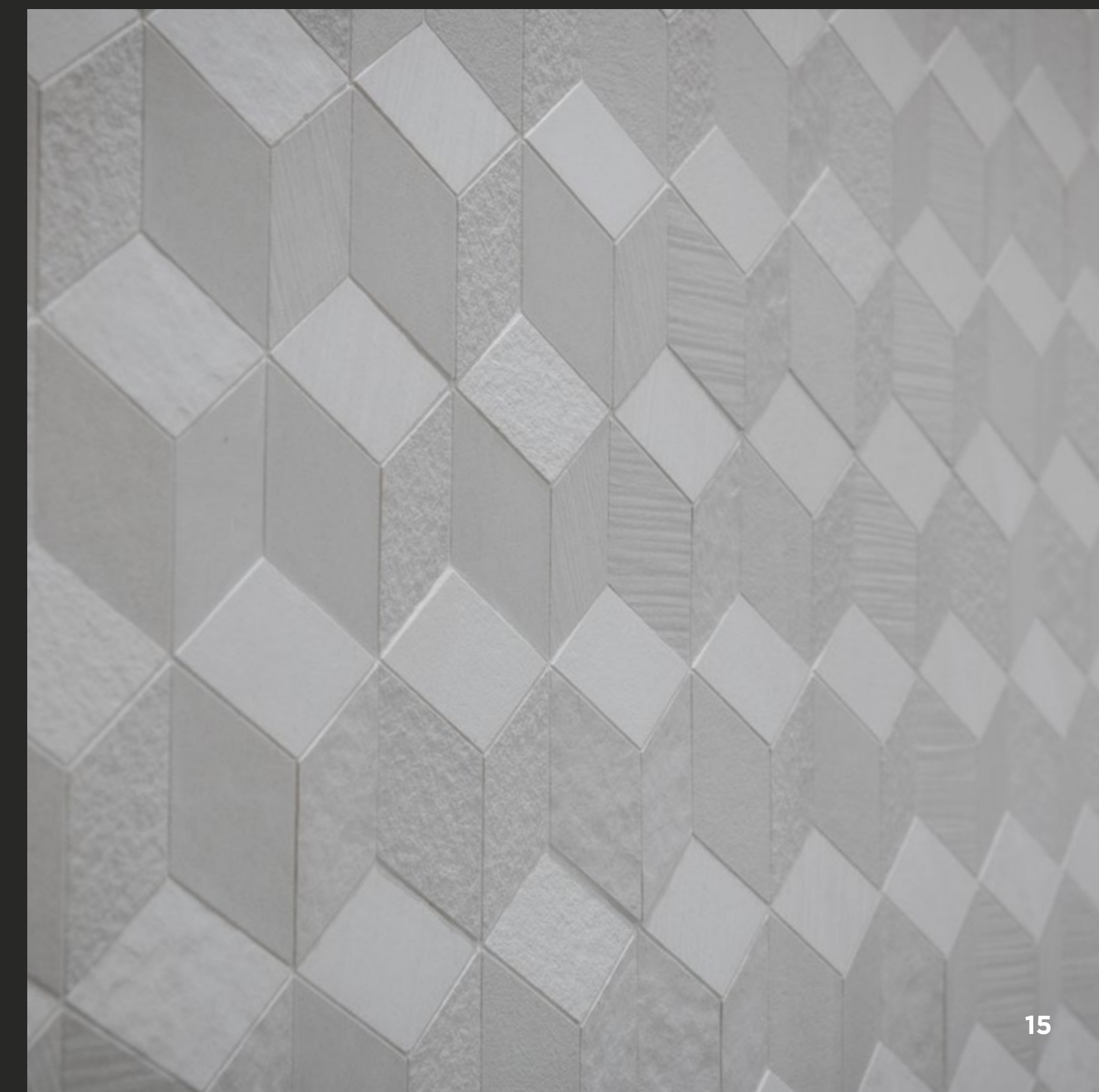

15

14.

WALL | PARETE

Light Crespo 60x120 cm / 24"x48" / ≠6 mm**Light Cubic 3D mix** 30x17 cm / 12"x6" / ≠6 mm

FLOOR | PAVIMENTO

Concrete Graphite 120x120 cm / 48"x48" / ≠12 mm**15.**

WALL | PARETE

Light Cubic 3D mix 30x17 cm / 12"x6" / ≠6 mm



16



17

16. / 17.

FLOOR | PAVIMENTO

Concrete Rope, Concrete White

120x120 cm / 48"x48" / ≠4.8 mm

Concrete Beige 30x60 cm / 12"x24" / ≠4.8 mm

30x30 cm / 12"x12" / ≠4.8 mm

Concrete Beige Stripes Mosaic

30x60 cm / 12"x24" / ≠4.8 mm

Mosaic 1.5x1.5 30x30 cm / 12"x12" / ≠4.8 mm

Action Mosaic 30x30 cm / 12"x12" / ≠4.8 mm

BRICK BAR

A strong minimal connotation with a vintage look. The **Brick Bar** guarantees the industrial effect recalling the classic brick of the New York lofts, but it has an important and fundamental ease of installation.

The 7.5x60cm strip structure is divided into four equal parts by means of a pre-incision designed to become a joint after grouting, forming metropolitan or domestic elements of space with a rediscovered taste on the wall but also on the floor, depending on the stylistic interpretations. **Brick Bar** is available in all **Gigacer** colours present with a 12mm thickness.

Una forte connotazione minimal con un aspetto a tratti vintage. Il **Brick Bar** garantisce l'effetto industrial richiamando il classico mattoncino dei loft newyorkesi ma presenta un'importante e fondamentale facilità di posa.

La struttura a listello 7,5x60 cm è divisa in quattro parti uguali tramite una pre-incisione studiata per diventare fuga dopo la stuccatura, formando in parete ma anche a pavimento elementi dello spazio metropolitani o domestici dal gusto ritrovato, a seconda delle interpretazioni stilistiche. **Brick Bar** è disponibile in tutti i colori **Gigacer** presenti con lo spessore 12 mm.

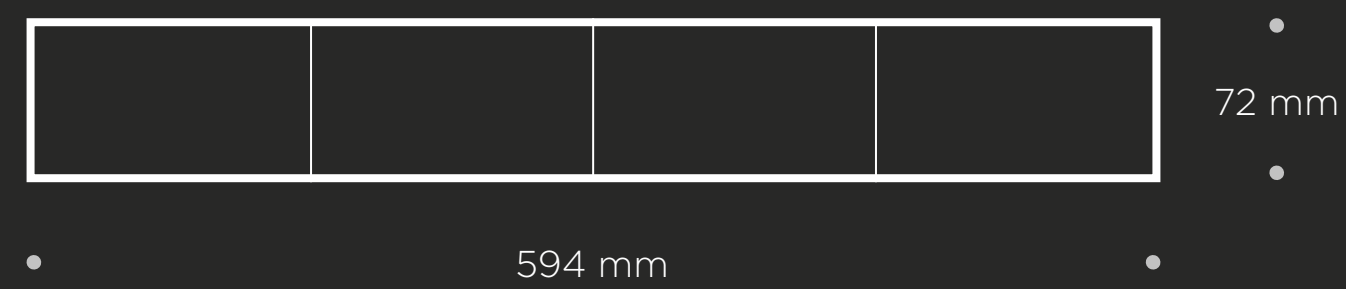
SIZES AND THICKNESSES **FORMATI E SPESSORI**

BRICK BAR
7,5x60 cm 3"x24"

≈12mm

ARGILLA / CONCEPT 1 / CONCRETE - MADE 2.0 / KREA / LIGHT / QUARRY

CONCEPT 1 | ≈ 12 mm
MAT | LEVIGATO



CONCRETE | ≈ 12 mm



MADE 2.0 MAT | ≈ 12 mm

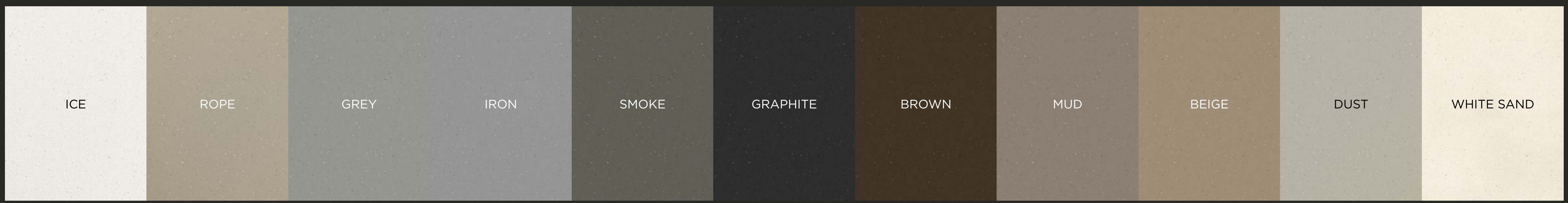

MADE 2.0 LEV | ≈ 12 mm



MADE 2.0 BOC | ≈ 12 mm



ARGILLA | ≈ 12 mm



KREA | ≈ 12 mm



QUARRY | ≈ 12 mm

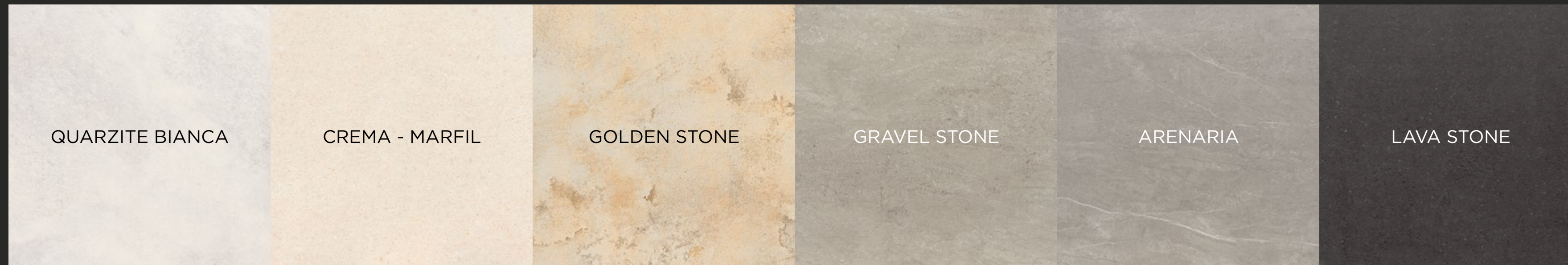

LIGHT | ≈ 12 mm





1.
WALL | PARETE
Krea Green, Krea Snow Brick Bar 7,5x60 / 3"x24" / ≠12 mm

2.
WALL | PARETE
Krea Green, Krea Snow Brick Bar 7,5x60 / 3"x24" / ≠12 mm
Krea Green 120x120 / 48"x48" / ≠6 mm
Krea Green, Krea Red, Krea Snow Small Hexagon 18x16 / 7"x6" / ≠4.8 mm



3.

WALL | PARETE
Krea Blue, Krea Snow Brick Bar 7,5x60 / 3"x24" / 12 mm



4.
PARETE | WALL:
Krea Green Brick Bar 7,5x60 / 3"x24" / ±12 mm

5.
PARETE | WALL:
Krea Red Brick Bar 7,5x60 / 3"x24" / ±12 mm

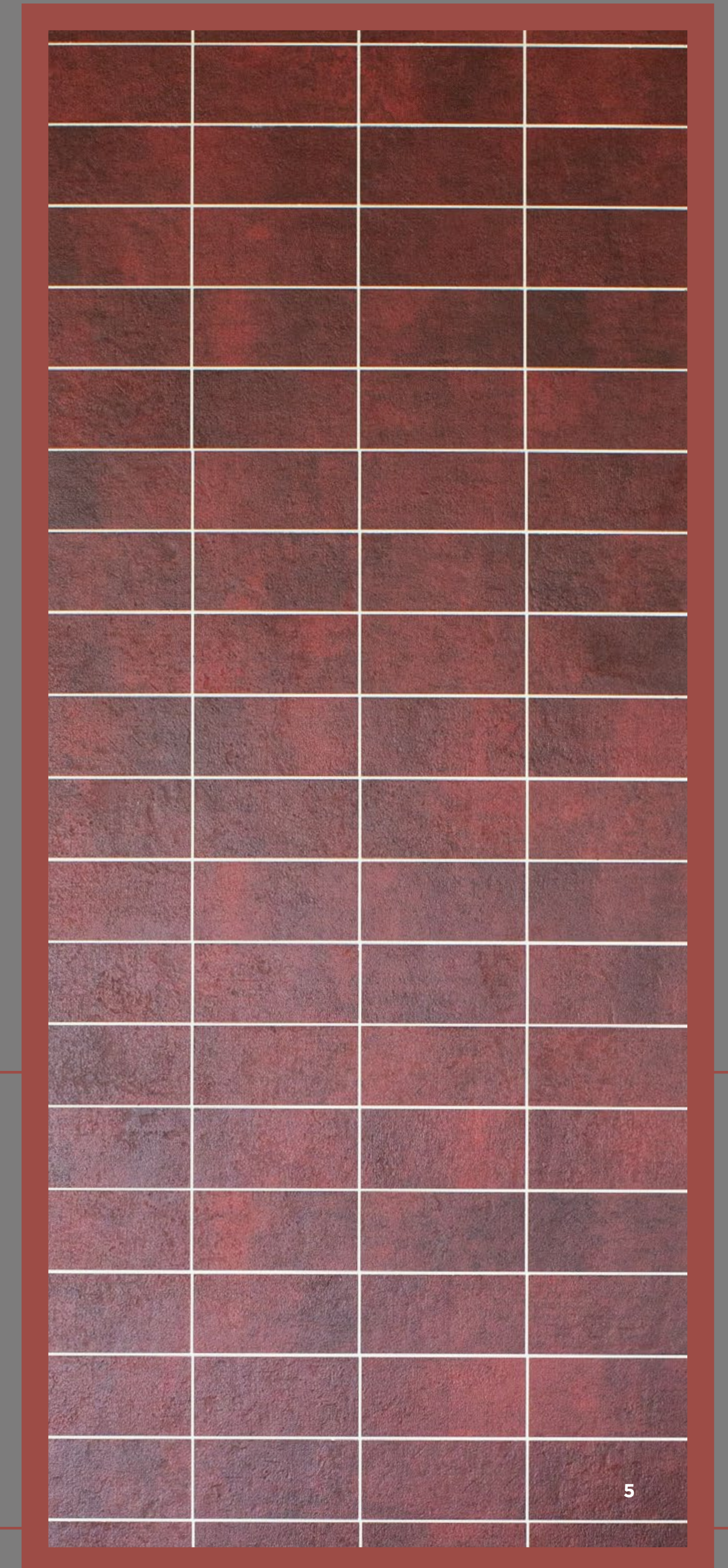



LAYOUT
SCHEMI DI POSA

The laying patterns are approximate.
Joint spacing recommended 2 mm.

Gli schemi di posa sono stati calcolati con una approssimazione.
Fuga consigliata 2 mm.

LAYOUT Page 21

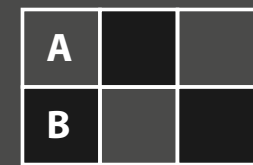

- A Small · 9x9 cm 50%
- B Small · 9x9 cm 50%

LAYOUT Page 11 - 13 - 15 - 18 - 19

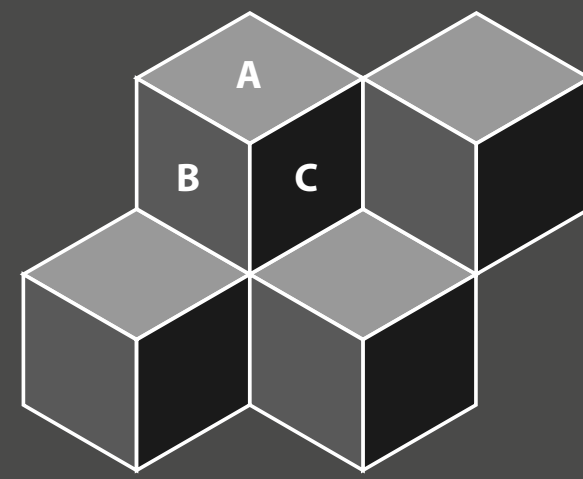

- A Diamond · 18x31 cm 33.33%
- B Diamond · 18x31 cm 33.33%
- C Diamond · 18x31 cm 33.33%

LAYOUT Page 12

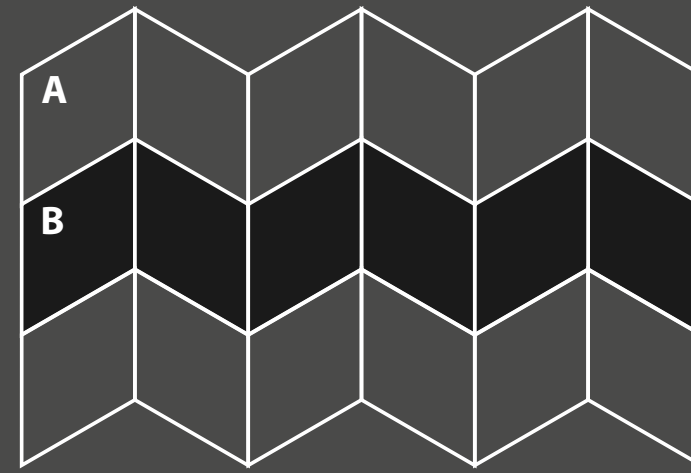

- A Diamond · 18x31 cm 50%
- B Diamond · 18x31 cm 50%

LAYOUT Page 8

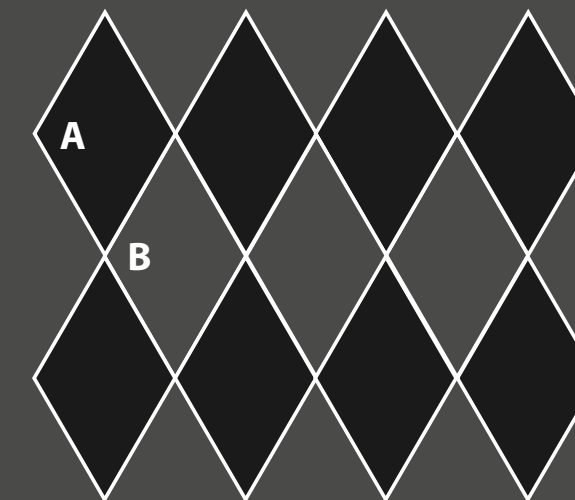

- A Diamond · 18x31 cm 50%
- B Diamond · 18x31 cm 50%

LAYOUT Page 10

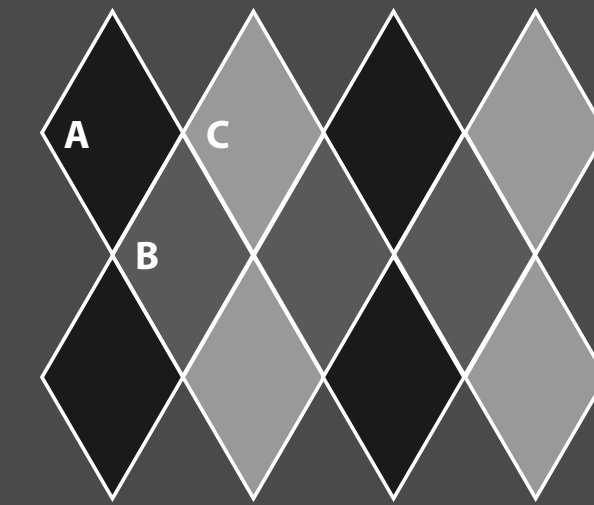

- A Diamond · 18x31 cm 40%
- B Diamond · 18x31 cm 20%
- C Diamond · 18x31 cm 40%

LAYOUT Page 21

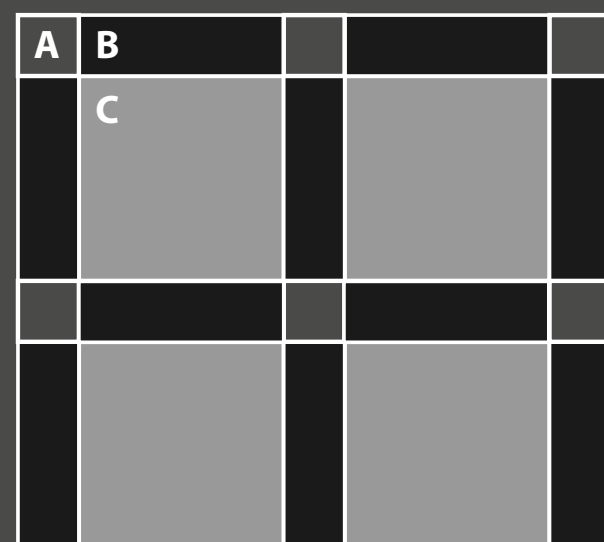

- A Small · 9x9 cm 5.33%
- B Plate · 9x30 cm 35.5%
- C 30x30 cm 59.17%

LAYOUT Page 19

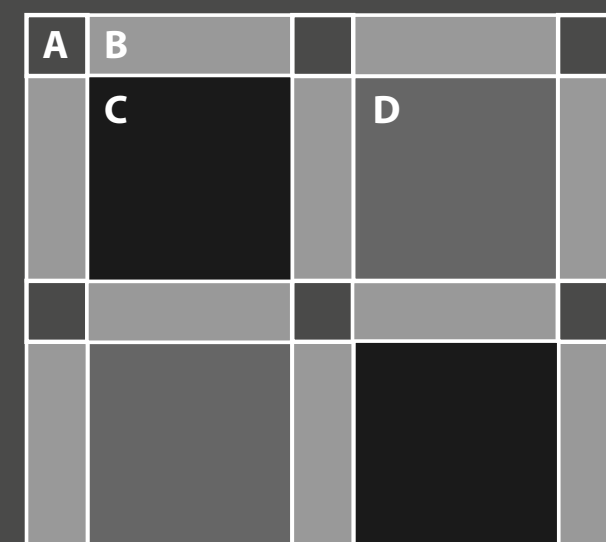

- A Small · 9x9 cm 5.33%
- B Plate · 9x30 cm 35.50%
- C 30x30 cm 29.59%
- D 30x30 cm 29.59%

LAYOUT Page 8

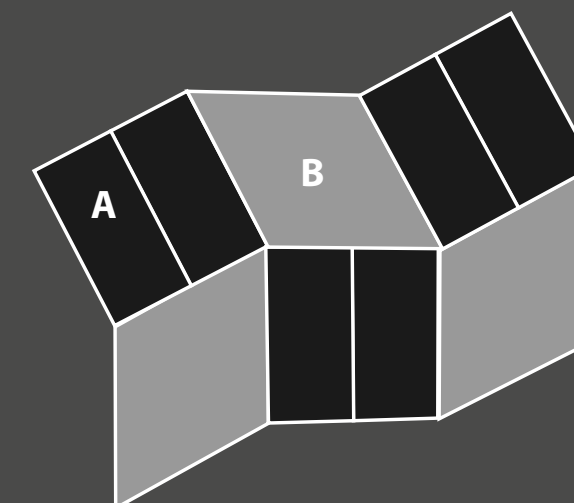

- A Brick · 9x18 cm 63%
- B Diamond · 18x31 cm 37%

LAYOUT Page 14 - 16

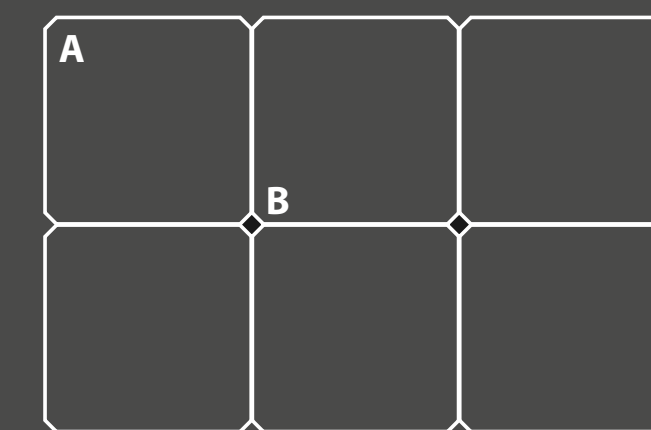

- A Octagon · 30x30 cm 99%
- B Button · 3x3 cm 1%

LAYOUT Page 7

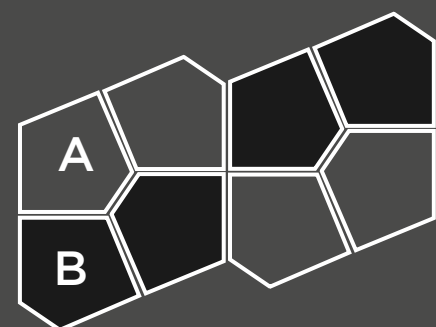

- A Small Pentagon · 17x10 cm 50%
- B Small Pentagon · 17x10 cm 50%

LAYOUT Page 9 - 18

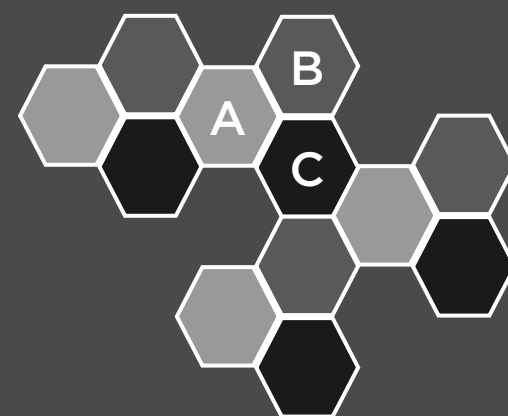

- A Small Hexagon · 18x16 cm 33.33%
- B Small Hexagon · 18x16 cm 33.33%
- C Small Hexagon · 18x16 cm 33.33%

LAYOUT Page 9

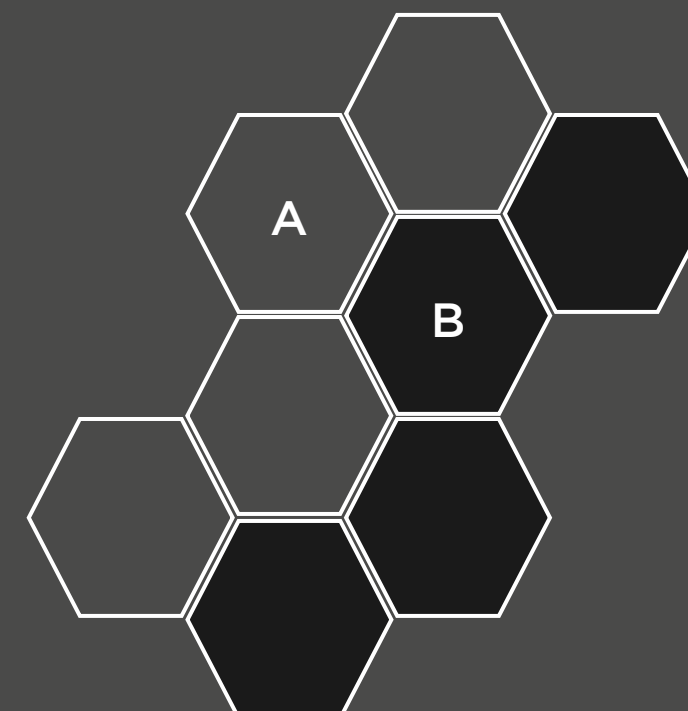

- A Large Hexagon · 36x31 cm 50%
- B Large Hexagon · 36x31 cm 50%

LAYOUT Page 17

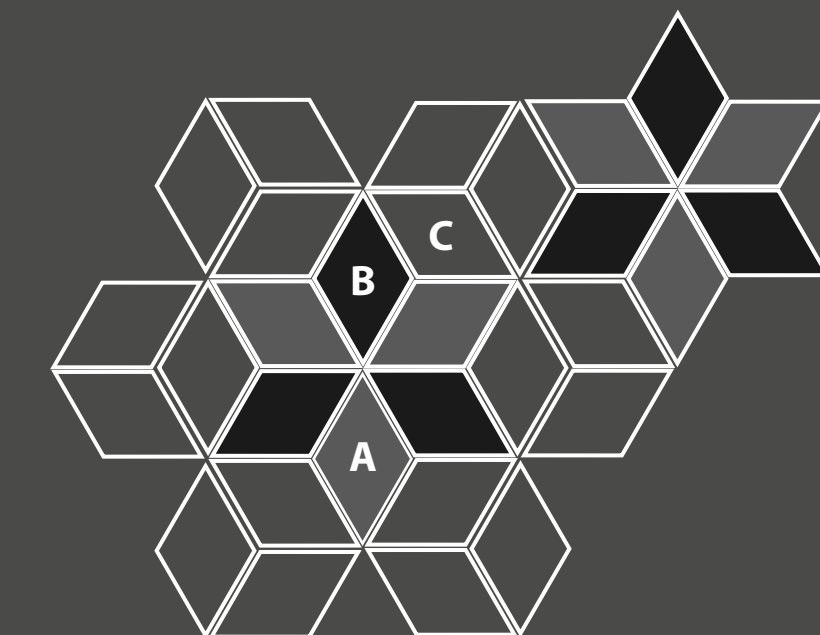

- A Diamond · 18x31 cm 33.33%
- B Diamond · 18x31 cm 33.33%
- C Diamond · 18x31 cm 33.33%

PRODUCT GUIDE
GUIDA PRODOTTO

SUSTAINABLE THINKING

We pay close attention to:

- the safety and comfort of our production staff;
- the respect for the environment in and around the factory;
- the safety of tile layers in the building site, which is guaranteed by the specially designed packaging that makes movement easier and that is completely recyclable.

We manufacture large porcelain slabs thanks to the application of advanced technologies, in accordance with the current European environmental standards (and often with even better results). For this reason the engines are installed in soundproof areas, the lighting around the production area is low emission, there is an environmental monitoring in real time, the complete packaging (sidepack) uses minimum quantities of cardboard and, however, the material used for packaging is completely recyclable and glueless. The new 4.8 thin slab is in fact the most advanced system concerning energy saving: it give us the possibility of manufacturing high quality porcelain stoneware tiles with a remarkable energy saving, both for firing and carriage.

TECHNOLOGICAL INNOVATION

An intelligent production process.

GIGACER production process starts from large porcelain slabs, size 120x120 cm, homogeneous multilayer. The slabs can then be cut in many other submultiples and worked again to get different finishes, preserving their top quality and aesthetic features.

These homogeneous multilayer porcelain slabs show superior technical and aesthetical characteristics thanks to a highly innovative technology. The equipment has been realized on purpose to manufacture large sizes and uses an innovative technology called "CONTINUA". This technology foresees a pre-compacting phase before pressing, that allows to achieve special decorative effects without using glazes, but only distributing the porcelain mixed powders on the body. The thickness of the manufactured slabs are 12 mm, 6 mm and 4.8 mm.

SOSTENIBILITÀ

Curiamo con particolare attenzione:

- la sicurezza ed il comfort del personale addetto alla produzione;
- il rispetto dell'ambiente in cui sorge lo stabilimento;
- la sicurezza del personale sul cantiere, garantita da imballaggi studiati per facilitare la movimentazione e completamente riciclabili.

Produciamo grandi lastre ceramiche grazie all'applicazione di tecnologie all'avanguardia, nel rispetto (spesso anche in senso molto migliorativo) delle vigenti normative europee sull'ambiente. Per questo i macchinari si trovano in ambienti insonorizzati, l'illuminazione della linea produttiva è a basso regime, esiste un monitoraggio ambientale in tempo reale, il sistema di imballaggio - sidepack - prevede, prima della pressatura, l'utilizzo di quantità di cartone minime e comunque i materiali dell'imballo sono completamente riciclabili e privi di colle.

La nuova lastra sottile 4.8 è di fatto il nuovo orizzonte del risparmio energetico in ceramica: offre la possibilità di produrre gres porcellanato di altissima qualità con notevole risparmio di energia sia durante il processo di cottura sia durante il trasporto.

INNOVAZIONE TECNOLOGICA

Un processo produttivo intelligente.

Il processo produttivo di GIGACER prevede la preparazione preliminare di un unico formato, grandi lastre in gres porcellanato 120x120 cm, multistrato a tutta massa, che possono essere successivamente tagliate e modificate a freddo in molteplici altri formati e superfici mantenendo la massima garanzia di requisiti tecnici qualitativi ed estetici.

Questa serie di lastre caratterizzate da superiori prerogative tecniche ed estetiche viene prodotta in gres porcellanato a tutta massa multistrato con una tecnologia assolutamente innovativa. L'impianto è stato progettato appositamente per produrre grandi formati e utilizza la tecnologia definita "CONTINUA" che prevede prima della pressatura, una fase di precompattazione della lastra multistrato a tutta massa che permette di ottenere speciali effetti decorativi senza ricorrere all'uso di smalti, ma solo con la distribuzione di impasti porcellanati colorati di qualità. Gli spessori delle lastre prodotte sono di 12 mm, 6 mm e 4.8 mm.





Gigacer Service is the firm's made to measure working service offered on all products. It enables slabs to be cut, perforated, polished and generally adapted to the individual project in line with the requisites of a specific client design. In this way the ceramic slabs can be used both to create decor elements and to personalise or adjust slab dimensions to flooring or decor designs. In this way the ceramic slabs can be matched with, or even identical to, the kitchen worktop, flights of steps, the bathroom worktop and even the basin in an infinity of possible forms and dimensions. Each single piece can be made in accordance with designers' instructions and technical drawings.

Gigacer Service è il servizio di lavorazioni su misura offerto da **Gigacer** su tutti i suoi prodotti. Consente di tagliare, forare, lucidare e in generale adattare le lastre al singolo progetto, seguendo le indicazioni di uno specifico disegno del cliente. In questo modo le lastre ceramiche possono essere utilizzate sia per realizzare elementi d'arredo, sia per personalizzare o adeguare al progetto le dimensioni di lastre per pavimento o rivestimento. Il pavimento o il rivestimento potrà così essere abbinato o addirittura identico al top cucina, ai gradini della scala, al top bagno o anche allo stesso lavabo, in una infinità di forme e dimensioni. Il pezzo unico viene realizzato anche seguendo le indicazioni e il disegno tecnico del progettista.

SPECIAL SERVICES SERVIZI SPECIALI

CHANGES ON REQUEST MODIFICHE SU RICHIESTA

It is possible to require the feasibility and the quotation for the following changes:

- squared top edge, instead of rounded
- unglazed top edge (on 12mm thickness the multilayer will be visible)
- bespoke sizes: please indicate X and Y in mm.

È possibile richiedere la fattibilità e la quotazione per le seguenti modifiche:

- top squadrato invece che arrotondato
- top non smaltato (nel 12mm sarà visibile il multilayer)
- misure non standard: indicare misura X e Y in mm

It is possible to request bespoke sizes on X, Y, Z and J. Minimum size 30mm, maximum 1900 for each variable.

It is possible to ask for one or both sides closed, if the staircase is open. The piece can be made without nose, only at 90°. All sizes must be specified (A, B and C).

Le misure X, Y, Z e J sono modificabili a piacimento. Misura minima 30mm, massima 1900 per ogni variabile.

È possibile richiedere il gradone con chiusura su un lato o su entrambi, nel caso la scala sia aperta. Il pezzo può essere realizzato anche a vela senza rientranza. È necessario indicare tutte le misure richieste (A, B e C).

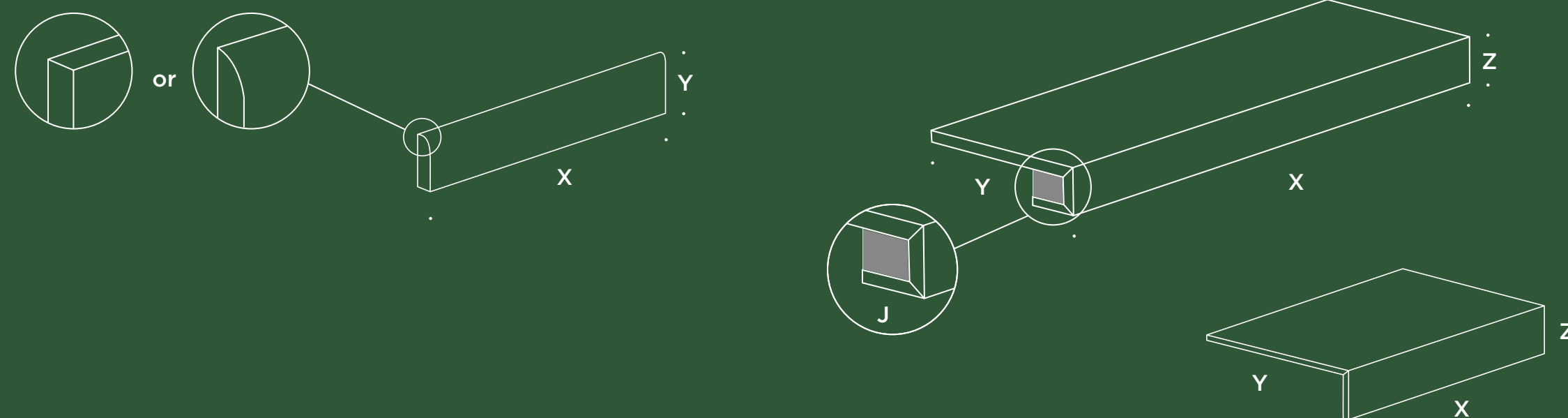

INTENDED USE CLASSIFICATION DESTINAZIONI D'USO









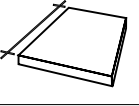

	NEW FLOORS	FLOOR RENOVATION	WALL COVERING	LIGHT COMMERCIAL	HEAVY COMMERCIAL	OUTDOOR	RAISED FLOOR	COUNTERTOPS AND KITCHENTOPS
	PAVIMENTI NUOVE COSTRUZIONI	PAVIMENTI IN RISTRUTTURAZIONI	RIVESTIMENTI	COMMERCIALE LEGGERO	COMMERCIALE PESANTE	ESTERNI	SOPRELEVATO	PIANI DI LAVORO
4,8 mm	+	++	++	+	--	-	--	-
12 mm multilayer	++	+	+	++	++	+	+	-
	Floor tiling on screed in new buildings.	Floor tiling on screed or on existing floor (in ceramic or natural stone) in buildings under renovation.	Wall covering.	Indoor public places subject to medium pedestrian traffic.	Indoor public places subject to heavy pedestrian traffic.	Outdoor places.	Raised floor with floating structure or PVC supports.	
	Posa a terra in nuove costruzioni su massetto.	Posa a terra su pavimenti esistenti, in ceramica o pietra naturale, o su massetto in costruzioni in stato di ristrutturazione.	Rivestimento muri.	Ambienti pubblici interni a medio traffico.	Ambienti pubblici interni ad alto traffico.	Ambienti esterni.	Pavimenti soprelavati con struttura flottante o posa su supporti in PVC.	

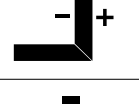
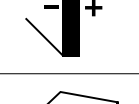
++ Recommended Consigliato
+ Suitable Appropriato

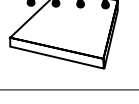
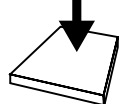
- Not recommended Non consigliato
-- Not suitable Non appropriato

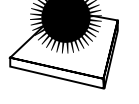

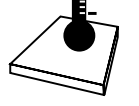
TECHNICAL SPECIFICATION CARATTERISTICHE TECNICHE

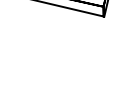
PORCELAIN SLABS LASTRE DI GRES PORCELLANATO ISO 13006 - G - BIa UGL (E ≤ 0,5%) UNI EN 14411 - G -					
	TECHNICAL SPECIFICATIONS CARATTERISTICHE TECNICHE	STANDARD NORMA ISO	THICKNESS SPESSORE	INTERNATIONAL STANDARDS VALORI PRESCRITTI DALLE NORME	AVERAGE GIGACER VALUE VALORE MEDIO GIGACER
	DIMENSIONAL CHARACTERISTICS CARATTERISTICHE DIMENSIONALI			S > 410	
	SIDES LATI	ISO 10545-2		± 0,6%	± 0,2%
	THICKNESS SPESSORE			± 5%	± 3%
	STRAIGHTNESS OF EDGES RETTILINEITÀ DEGLI SPIGOLI			± 0,5%	± 0,2%
	RECTANGULARITY ORTOGONALITÀ			± 0,6%	± 0,2%
	SURFACE FLATNESS PLANARITÀ			± 0,5%	± 0,2%
	WATER ABSORPTION ASSORBIMENTO D'ACQUA	ISO 10545-3		≤ 0,5%	≤ 0,1%
	BENDING STRENGTH RESISTENZA ALLA FLESSIONE	ISO 10545-4	≠ 4.8 mm	≥ 35N/mm ²	≥ 40 N/mm ²
			≠ 6 mm	≥ 35N/mm ²	≥ 40 N/mm ²
			≠ 12 mm	≥ 35N/mm ²	≥ 40 N/mm ²
	MODULUS OF RUPTURE MODULO DI ROTTURA	ISO 10545-4	≠ 4.8 mm	> 700N (sp. < 7,5mm)	> 700 N
			≠ 6 mm	> 700N (sp. < 7,5mm)	> 700 N
			≠ 12 mm	> 1.300N (sp. ≥ 7,5mm)	≥ 4000 N
			≠ 24 mm	> 1.300N (sp. ≥ 7,5mm)	18,14 kN (=18.140 kgF)
	RESISTANCE TO DEEP ABRASION RESISTENZA ALL'ABRAZIONE PROFONDA	ISO 10545-6		≤ 175mm ³	≤ 145 mm ³
	COEFFICIENT OF LINEAR THERMAL EXPANSION COEFFICIENTE DI DILATAZIONE TERMICA LINEARE	ISO 10545-8		≤ 9x10 ⁻⁶ °C ⁻¹	≤ 7x10 ⁻⁶ °C ⁻¹
	RESISTANCE TO THERMAL SHOCKS RESISTENZA AGLI SBALZI TERMICI			AVAILABLE METHOD METODO DISPONIBILE	RESISTANT RESISTE
	FROST RESISTANCE RESISTENZA AL GELO	ISO 10545-12		AVAILABLE METHOD METODO DISPONIBILE	RESISTANT RESISTE
	RESISTANCE TO CHEMICAL ATTACKS RESISTENZA ALL'ATTACCO CHIMICO	ISO 10545-13		min. UB	RESISTANT RESISTE
	STAIN RESISTANCE RESISTENZA ALLE MACCHIE	ISO 10545-14		AVAILABLE METHOD METODO DISPONIBILE	RESISTANT RESISTE



We produce technical unglazed porcelain stoneware slabs, and some light impurities and dots must be considered as a standard feature of the product. / Trattandosi di un prodotto tecnico a solo impasto senza smalto alcune impurità e puntature visibili nei colori chiari sono da considerarsi una caratteristica tecnica del prodotto.

PACKAGING IMBALLI

We pay close attention to the 4.8mm products packaging, to avoid any risk of breakage during shipping. The cardboards used come from recycled sources 100%, and wood, fumigated according to ISPM-15, supports the weight of any pallet (gigacer pallets) stacked. It is important to stack only pallets of the same size. Gigacer assumes no responsibility for damages caused by incorrect handling of the material loading or unloading, unauthorized handling or accidents of any kind.

Curiamo con particolare attenzione gli imballi del materiale 4,8 mm e 12 mm per scongiurare qualsiasi rischio di rottura dovuta alle sollecitazioni del viaggio. Il cartone utilizzato proviene al 100% da fonti riciclate e il legno, fumigato secondo le norme ISPM-15, sostiene il peso di eventuali pallet (sempre Gigacer) sovrapposti scaricandolo a terra. È importante sovrapporre i pallet dello stesso formato, e non euro pallet con pallet 120x120. Gigacer non si assume nessuna responsabilità per danni causati al materiale da errate manovre di carico o scarico, da movimentazioni non autorizzate o da eventi accidentali di qualsiasi tipo.

Size / Formato (cm)	Pallet (cm)	Pezzi x collo PCS/BX	M ² x collo SQM/BX	Kg x collo KG/BX	Colli x pallet BX/PLT	M ² x pallet SQM/PLT	Kg x pallet KG/PLT
12 mm							
Brick Bar 7,5x60	80x120	12	0,54	14,00	40	2,16	593
Mosaic 30x30 (3x3 mix)	-	8	-	22,50	-	-	-
Mosaic Trail 30x30 (2x10)	-	8	-	20,20	-	-	-
6 mm							
Mosaic 30x30 (0,7x0,7)	-	10	-	13,00	-	-	-
Mosaic 30x30 (1,5x1,5)	-	10	-	13,00	-	-	-
Mosaic 30x30 (1,5x1,5 mix)	-	10	-	13,00	-	-	-
Mosaic 30x30 (3x3 mix)	-	10	-	13,00	-	-	-
Mosaic 30x30 (3x6)	-	10	-	13,00	-	-	-
Mosaic 30x30 (3x6 mix)	-	10	-	13,00	-	-	-
Mosaic 3d cubic 17x30	-	6	-	6,00	-	-	-
Action Mosaic 30x30 (4,4x5,2)	-	10	-	13,00	-	-	-
Wall Mosaic 30x30	-	10	-	13,00	-	-	-
Stripes Mosaic 15x120	-	4	-	7,00	-	-	-
Stripes Mosaic 15x120 mix	-	4	-	7,00	-	-	-
Stripes Mosaic 30x60	-	6	-	9,50	-	-	-
4.8 mm							
Mosaic 30x30 (0,7x0,7)	-	10	-	13,00	-	-	-
Mosaic 30x30 (1,5x1,5)	-	10	-	13,00	-	-	-
Mosaic 30x30 (1,5x1,5 mix)	-	10	-	13,00	-	-	-
Mosaic 30x30 (3x6)	-	10	-	13,00	-	-	-
Action Mosaic 30x30 (4,4x5,2)	-	10	-	13,00	-	-	-
Wall Mosaic 30x30	-	10	-	13,00	-	-	-
Stripes Mosaic 30x60	-	6	-	9,50	-	-	-
Stripes Mosaic 15x120	-	4	-	7,00	-	-	-
Stripes Mosaic 15x120 mix	-	4	-	7,00	-	-	-
Small Pentagon	-	24	0,96	11,50	24	23,04	316
Small Hexagon	-	11	0,23	3,00	-	-	-
Large Hexagon	-	14	1,18	13,00	-	-	-
Button	-	22	0,02	0,39	-	-	-
Small	-	44	0,36	3,95	-	-	-
Brick	-	22	0,36	3,95	-	-	-
Plate	-	22	0,60	6,45	-	-	-
Octagon	-	22	1,98	23,70	-	-	-
Triangle	-	18	0,24	2,92	-	-	-
Diamond	-	9	0,24	2,92	-	-	-

CERTIFICATIONS CERTIFICAZIONI

GIGACER has achieved the process certifications ISO 9001:2015 e ISO 14001:2015. GIGACER has achieved the process certifications UNI EN 14411:2012. The quality of GIGACER products is constantly monitored with tests made by the main international certification laboratories. The last certification achieved is the QB-UPEC in some surfaces, with brilliant results. It is possible to download the list of Gigacer products that obtained QB-UPEC certification with all the values at the following url: www.cstb.fr

For more information visit www.gigacer.it

GIGACER ha conseguito le certificazioni di processo ISO 9001:2015 e ISO 14001:2015. GIGACER ha conseguito le certificazioni UNI EN 14411:2012. La qualità dei prodotti GIGACER viene controllata costantemente tramite test effettuati dai principali laboratori ed enti di certificazione internazionali. L'ultima certificazione ottenuta, in ordine di tempo, è la QB-UPEC per alcune superfici, con risultati brillanti. È possibile scaricare la lista completa dei prodotti Gigacer che hanno ottenuto la certificazione QB-UPEC, completa di valori, al seguente url: www.cstb.fr

Per maggiori informazioni vai su www.gigacer.it



MADE IN ITALY
MADE IN FAENZA

Does not damage with chemical detergents anticovid. / Non si danneggia con i detergenti chimici anticovid.

Real colours and decorations might slightly differ from those depicted in this catalogue. Quanto contenuto nel catalogo è puramente indicativo riguardo a colori e decorazioni.



GIGACER S.P.A.
via Caltagirone, n.72 | 48018 Faenza (RA) ITALY
Tel. +39 0546 637 111 | Fax +39 0546 637 127
info@gigacer.it
gigacer.it